



60V, Step-Down, 1A LED Driver

Features

- Max. 1A constant output current
- 97% efficiency @ input voltage 48V, loading condition 350mA, 12 LEDs in series
- 9~60V wide input voltage range
- Hysteretic PFM eliminates external compensation design
- Settable output current
- Integrated power switch with 0.35ohm Rds(on)
- Full protections: UVLO/Start-Up/OCP/ Thermal/ LED Open-/ LED Short- Circuited
- Only 5 external components required

Product Description

MBI6661 is a high efficiency, constant current and step-down DC/DC converter. It is designed to deliver constant current to light up high power LED with only 5 external components. By hysteretic PFM control scheme, MBI6661 omits the external compensation design.

The output current of MBI6661 can be programmed by an external resistor and LED dimming can be controlled via pulse width modulation (PWM) through DIM pin. In addition, the start-up function limits the inrush current while the power is on. MBI6661 also features under voltage lock out (UVLO), over temperature protection (OTP), and over current protection (OCP) to guard the system to be robust and keep the IC away from being damaged resulting from LED open-circuited, short-circuited and other abnormal events.

Additionally, to ensure the system reliability, MBI6661 builds thermal protection (TP) function inside. This function protects IC from overheating in various application conditions. MBI6661 provides thermal-enhanced packages as well to handle power dissipation more efficiently. MBI6661 is available in TO-252, SOP-8 packages.

Applications

- Signage and Decorative LED Lighting
- Automotive LED Lighting
- High Power LED Lighting
- Constant Current Source

Surface Mount Device

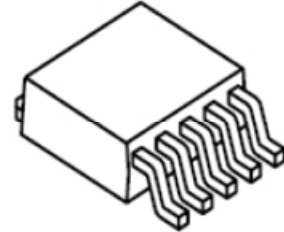

GSD: TO-252-5L

Small Outline Package



GD: SOP8L-150-1.27

MBI6661**60V, Step-Down, 1A LED Driver**

Pin Configuration

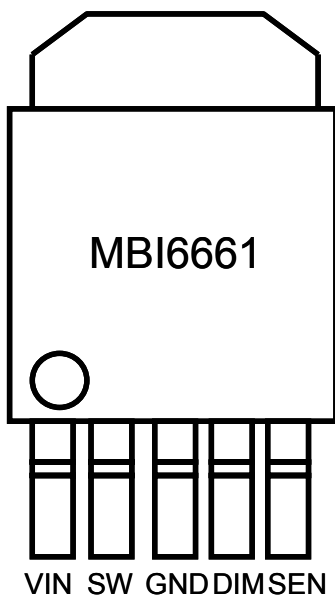

MBI6661GSD

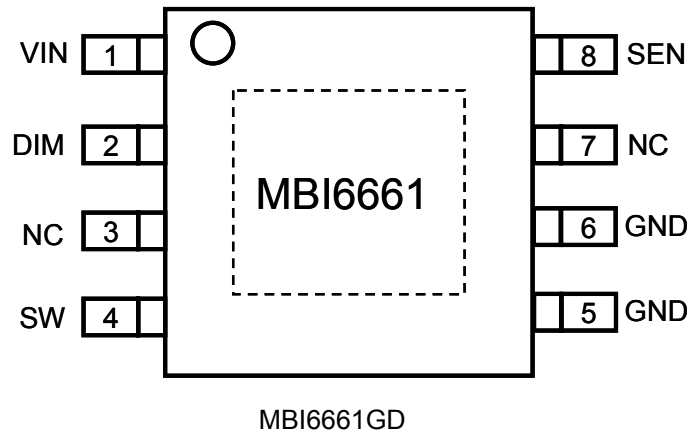

MBI6661GD

Pin Description

Pin Name	Function
GND	Ground terminal for control logic and current sink
SW	Switch output terminal
DIM	Dimming control terminal
SEN	Output current sense terminal
VIN	Supply voltage terminal
NC	No connection
Thermal Pad	Power dissipation terminal connected to GND*

*To improve the noise immunity, the thermal pad is suggested to connect to GND on PCB. In addition, when a heat-conducting copper foil on PCB is soldered with thermal pad, the desired thermal conductivity will be improved.

MBI6661

60V, Step-Down, 1A LED Driver

Typical Application Circuit

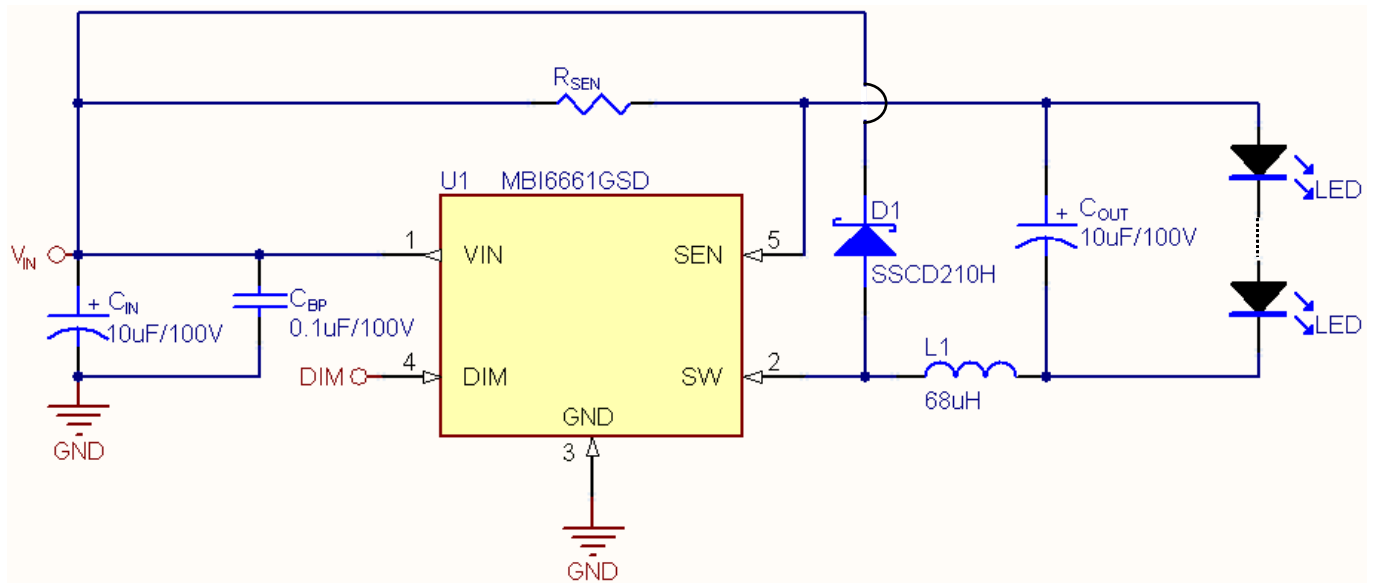

Fig. 1

- R_{SEN}: Viking, CS05FTEUR200, 0805
- C_{IN}: J. C. TALLY, Electrolytic Capacitor
- C_{BP}: Murata/Holystone, 0.1µF, 0805, X7R, Ceramic Capacitor
- C_{OUT} (Optional): J. C. TALLY, Electrolytic Capacitor
- L1: GANG SONG, GSDS106C2-680M
- D1: ZOWIE, SSCD210H

Functional Diagram

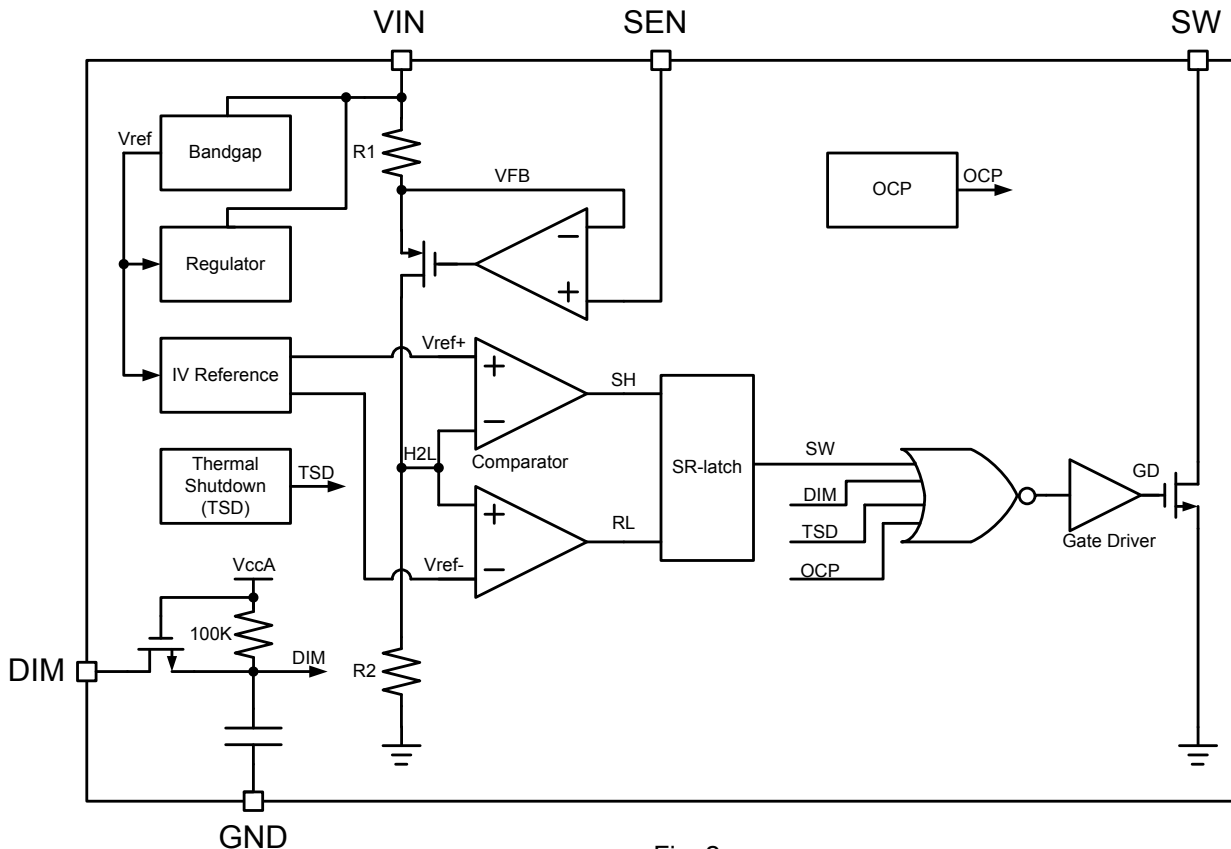

Fig. 2

MBI6661**60V, Step-Down, 1A LED Driver**

Maximum Ratings

Operation above the maximum ratings may cause device failure.

Characteristic		Symbol	Rating	Unit
Supply Voltage		V_{IN}	-0.3~75	V
Output Current		I_{OUT}	1.2	A
Sustaining Voltage at DIM pin		V_{DIM}	-0.3~60	V
Sustaining Voltage at SW pin		V_{SW}	-0.3~70	V
GND Terminal Current		I_{GND}	1.2	A
Power Dissipation (On 4 Layer PCB, $T_a=25^{\circ}C$)*	GSD Type	P_D	3.80	W
Thermal Resistance (By simulation, on 4 Layer PCB)*		$R_{th(j-a)}$	32.9	$^{\circ}C/W$
Empirical Thermal Resistance** (On PCB, $T_a=25^{\circ}C$)			35.42	$^{\circ}C/W$
Power Dissipation (On 4 Layer PCB, $T_a=25^{\circ}C$)*	GD Type	P_D	3.13	W
Thermal Resistance (By simulation, on 4 Layer PCB)*		$R_{th(j-a)}$	40	$^{\circ}C/W$
Empirical Thermal Resistance** (On PCB, $T_a=25^{\circ}C$)			84.9	$^{\circ}C/W$
Junction Temperature		$T_{j,max}$	150***	$^{\circ}C$
Operating Ambient Temperature		T_{opr}	-40~+85	$^{\circ}C$
Storage Temperature		T_{stg}	-55~+150	$^{\circ}C$

*The PCB size is 76.2mm*114.3mm in simulation. Please refer to JEDEC JESD51.

** The PCB area is 4 times larger than that of IC's and without extra heat sink.

*** Operation at the maximum rating for extended periods may reduce the device reliability; therefore, the suggested operation temperature of the device (T_{opr}) is under $125^{\circ}C$.

Note: The performance of thermal dissipation is strongly related to the size of thermal pad, thickness and layer numbers of the PCB. The empirical thermal resistance may be different from simulative value. Users should plan for expected thermal dissipation performance by selecting package and arranging layout of the PCB to maximize the capability.

MBI6661**60V, Step-Down, 1A LED Driver**

Electrical Characteristics

Test condition: $V_{IN}=24V$, $V_{OUT}=3.6V$, $L1=68\mu H$, $C_{IN}=C_{OUT}=10\mu F$, $T_A=25^\circ C$; unless otherwise specified.

Characteristics	Symbol	Condition	Min.	Typ.	Max.	Unit
Supply Voltage	V_{IN}	-	9	-	60	V
Supply Current	I_{IN}	$V_{IN}=9V\sim 60V$	-	1.5	4	mA
Output Current	I_{OUT}	-	-	-	1000	mA
Output Current Accuracy	dI_{OUT}/I_{OUT}	$350mA \leq I_{OUT} \leq 1000mA$,	-	± 3	± 5	%
SW Dropout Voltage	V_{SW}	$I_{OUT}=350mA$	-	0.3	-	V
Internal Propagation Delay Time	T_{pd}	-	100	200	300	ns
Efficiency	-	$V_{IN}=48V$, $I_{OUT}=350mA$, $V_{OUT}=43V$	-	97	-	%
DIM Input Voltage	"H" level	V_{IH}	-	2.5	-	V
	"L" level	V_{IL}	-	-	0.8	V
Switch ON Resistance	$R_{ds(on)}$	$V_{IN}=12V$; refer to test circuit (b)	-	0.35	-	Ω
Minimum Switch ON Time*	$T_{ON,MIN}$	-	100	350	450	ns
Minimum Switch OFF Time*	$T_{OFF,MIN}$	-	100	350	450	ns
Recommended Duty Cycle Range of SW*	D_{sw}	-	20	-	80	%
Maximum Operating frequency	$Freq_{MAX}$	-	40	-	1000	kHz
CURRENT SENSE						
Mean SEN Voltage	V_{SEN}	$V_{IN}=10V$, $V1=1V$, refer to test circuit (c)	95	100	105	mV
THERMAL OVERLOAD						
Thermal Shutdown Threshold*	T_{SD}	-	145	155	175	$^\circ C$
Thermal Shutdown Hysteresis*	T_{SD-HYS}	-	20	30	40	$^\circ C$
UNDER VOLTAGE LOCK OUT						
UVLO Voltage	-	$T_A=-40\sim 85^\circ C$	7.4	7.8	8.2	V
UVLO Hysteresis	-	-	0.15	0.25	0.35	V
Start Up Voltage	-	-	7.6	8.0	8.4	V
OVER CURRENT PROTECTION						
Over Current Threshold*	-	-	-	1.7	-	A
DIMMING						
Duty Cycle Range of PWM Signal Applied to DIM pin	$Duty_{DIM}$	PWM frequency: 100Hz~1kHz	1	-	100	%

*Parameters are not tested at production. Parameters are guaranteed by design.

MBI6661

60V, Step-Down, 1A LED Driver

Test Circuit for Electrical Characteristics

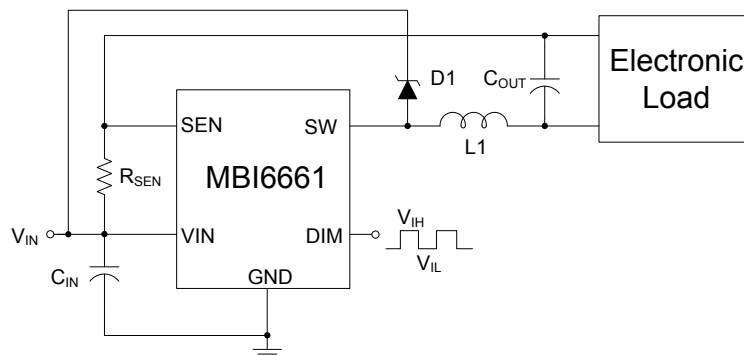

(a)

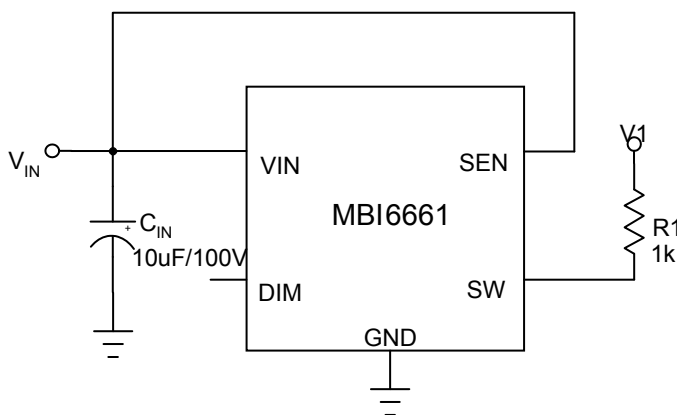

(b)

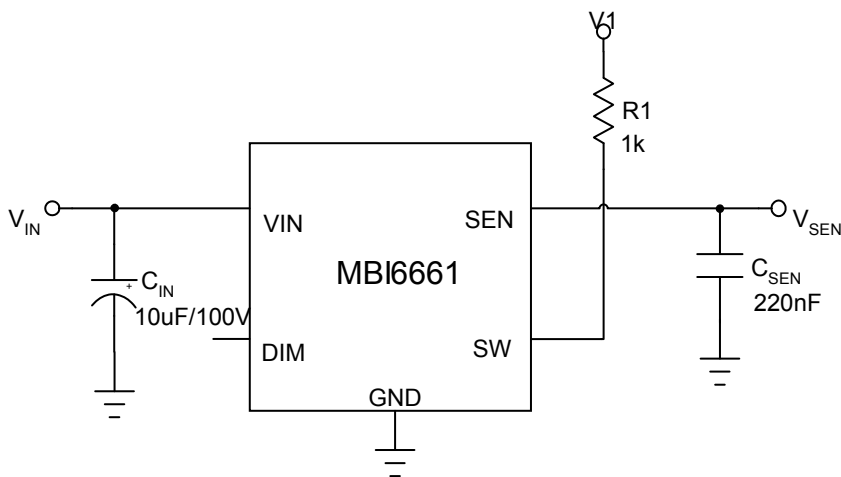

(c)

Fig. 3

MBI6661

60V, Step-Down, 1A LED Driver

Typical Performance Characteristics

Please refer to Typical Application Circuit, $L1=68\mu\text{H}$, $C_{IN}=C_{OUT}=10\mu\text{F}$, $T_A=25^\circ\text{C}$, unless otherwise specified.

1-LED $V_F=3.6\text{V}$; 2-LED $V_F=7.2\text{V}$; 3-LED $V_F=10.8\text{V}$; 4-LED $V_F=14.4\text{V}$; 5-LED $V_F=18\text{V}$

Efficiency vs. LED Cascaded Number at Various Input Voltage

Efficiency vs. LED Cascaded Number @ $L1=68\mu\text{H}$

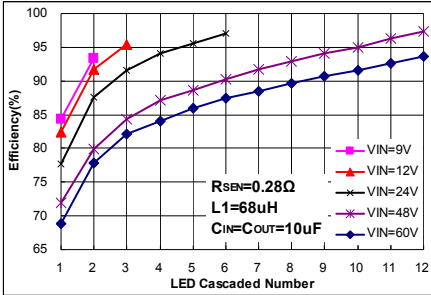

$I_{OUT}=350\text{mA}$

Fig. 4

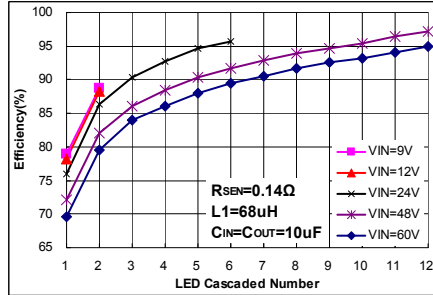

$I_{OUT}=700\text{mA}$

Fig. 5

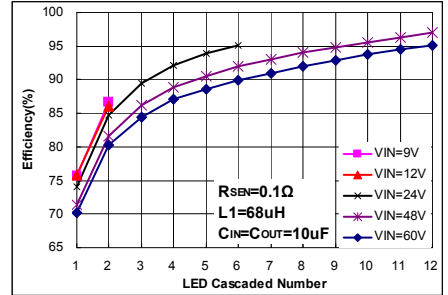

$I_{OUT}=1000\text{mA}$

Fig. 6

Efficiency vs. LED Cascaded Number @ $L1=100\mu\text{H}$

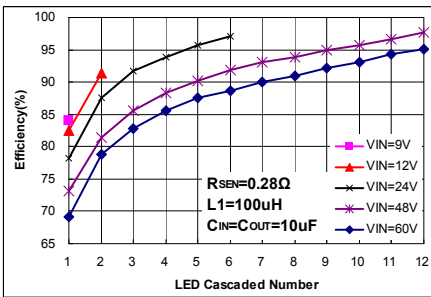

$I_{OUT}=350\text{mA}$

Fig. 7

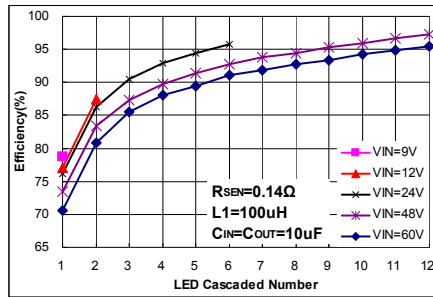

$I_{OUT}=700\text{mA}$

Fig. 8

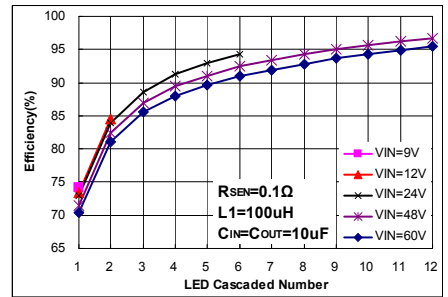

$I_{OUT}=1000\text{mA}$

Fig. 9

MBI6661

60V, Step-Down, 1A LED Driver

Output Current vs. Input Voltage at Various LED Cascaded Numbers

Output Current vs. Input Voltage @ L1=68uH

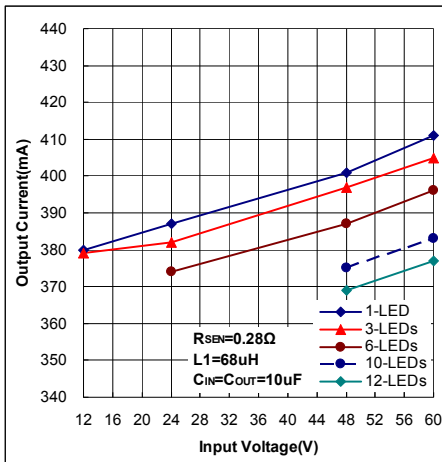

I_{OUT}=350mA

Fig. 10

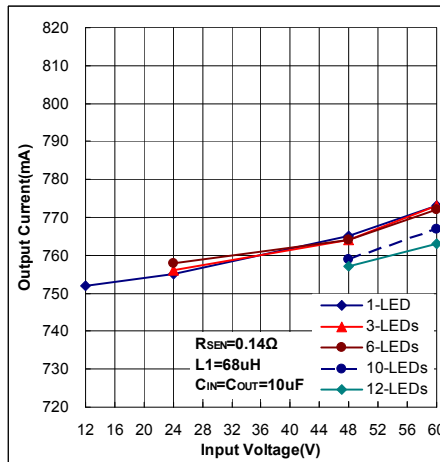

I_{OUT}=700mA

Fig. 11

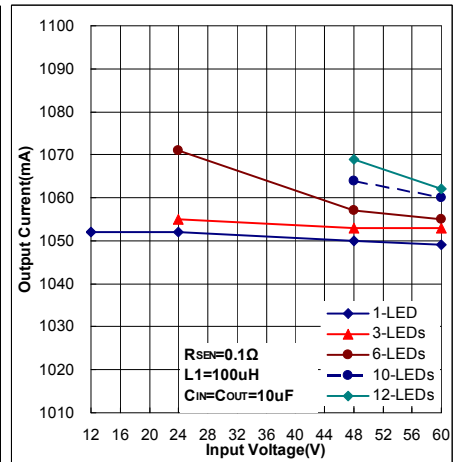

I_{OUT}=1000mA

Fig. 12

Output Current vs. Input Voltage @ L1=100uH

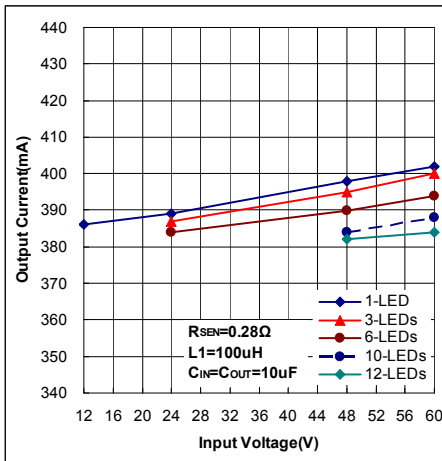

I_{OUT}=350mA

Fig. 13

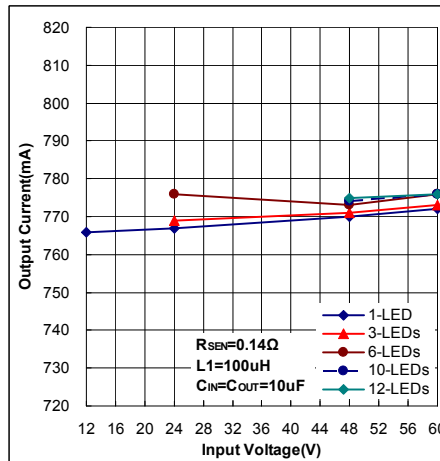

I_{OUT}=700mA

Fig. 14

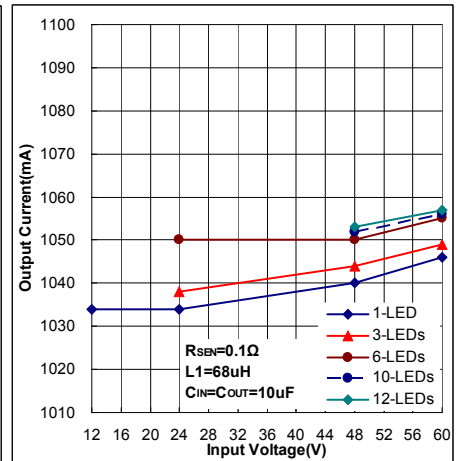

I_{OUT}=1000mA

Fig. 15

MBI6661

60V, Step-Down, 1A LED Driver

Output Current vs. LED Cascaded Number at Various Input Voltage

Output Current vs. LED Cascaded Number @ L1=68uH

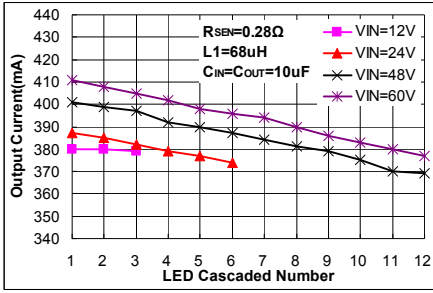

I_{OUT}=350mA

Fig. 16

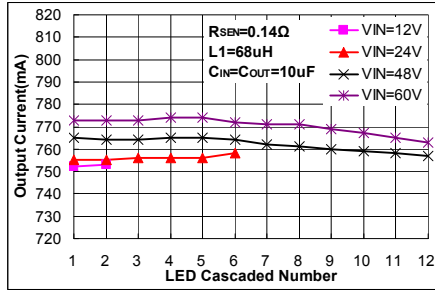

I_{OUT}=700mA

Fig. 17

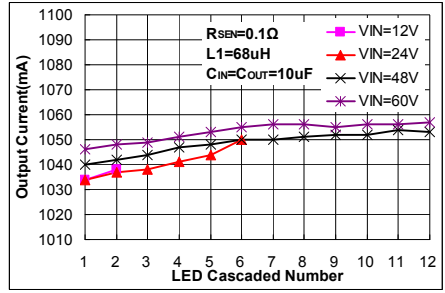

I_{OUT}=1000mA

Fig. 18

Output Current vs. LED Cascaded Number @ L1=100uH

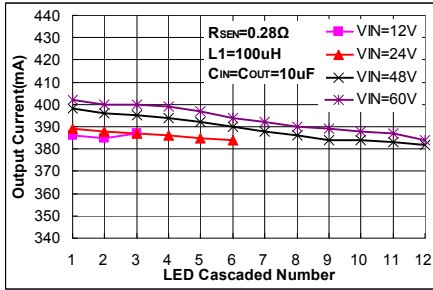

I_{OUT}=350mA

Fig. 19

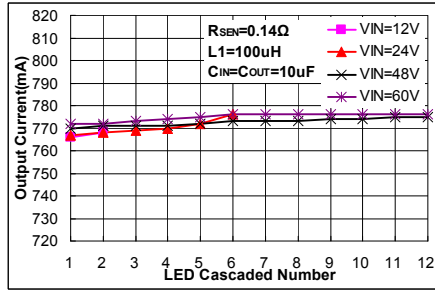

I_{OUT}=700mA

Fig. 20

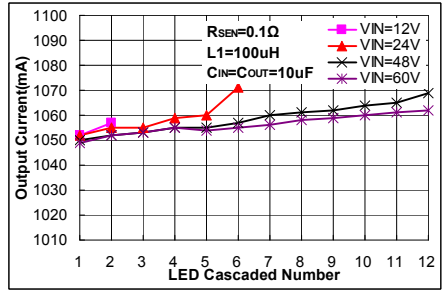

I_{OUT}=1000mA

Fig. 21

MBI6661

60V, Step-Down, 1A LED Driver

Switching Frequency vs. LED Cascaded Number at Various Inductor

Switching Frequency vs. LED Cascaded Number @ $V_{IN}=12V$

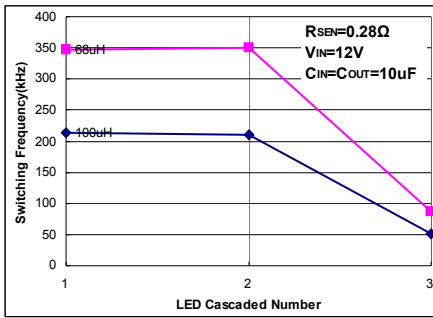

$I_{OUT}=350mA$

Fig. 22

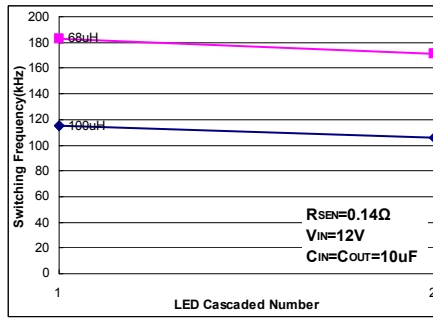

$I_{OUT}=700mA$

Fig. 23

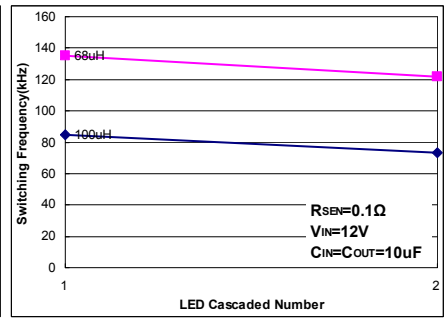

$I_{OUT}=1000mA$

Fig. 24

Switching Frequency vs. LED Cascaded Number @ $V_{IN}=24V$

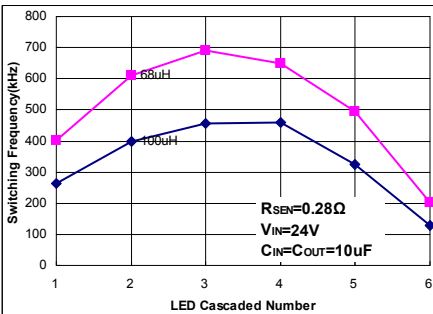

$I_{OUT}=350mA$

Fig. 25

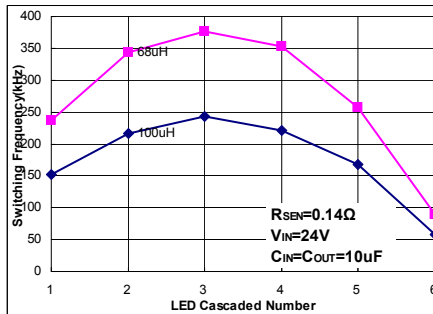

$I_{OUT}=700mA$

Fig. 26

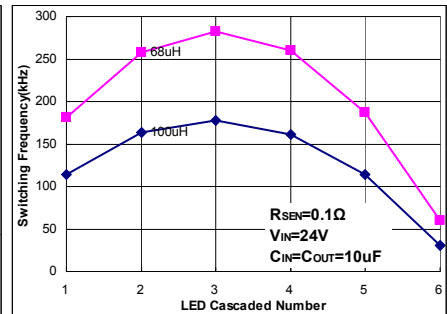

$I_{OUT}=1000mA$

Fig. 27

Switching Frequency vs. LED Cascaded Number @ $V_{IN}=48V$

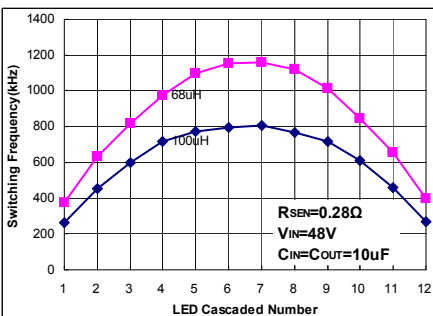

$I_{OUT}=350mA$

Fig. 28

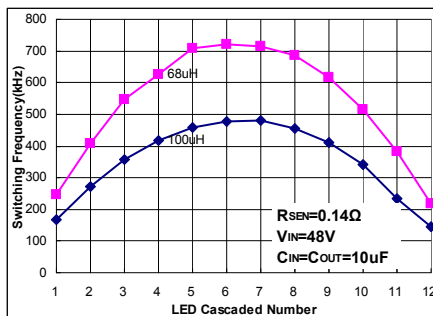

$I_{OUT}=700mA$

Fig. 29

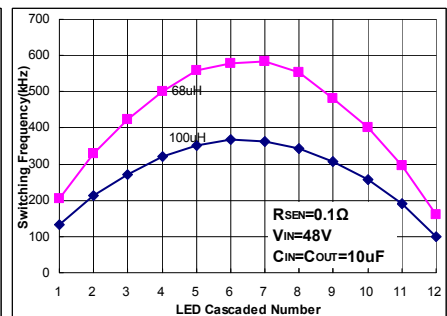

$I_{OUT}=1000mA$

Fig. 30

MBI6661

60V, Step-Down, 1A LED Driver

Dimming and Switching Waveforms

Dimming Waveform

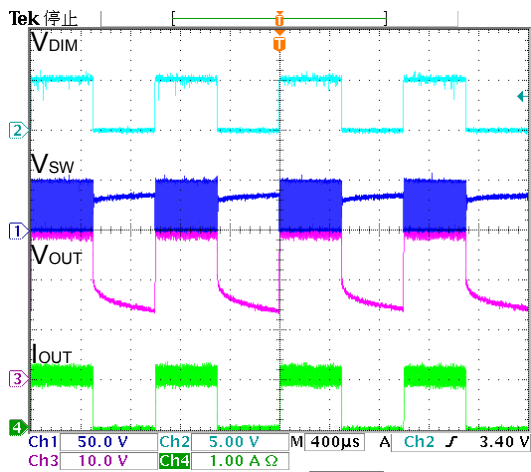

$V_{IN}=48V, R_{SEN}=0.1\Omega, D_{SW}=50\%$

Fig. 31

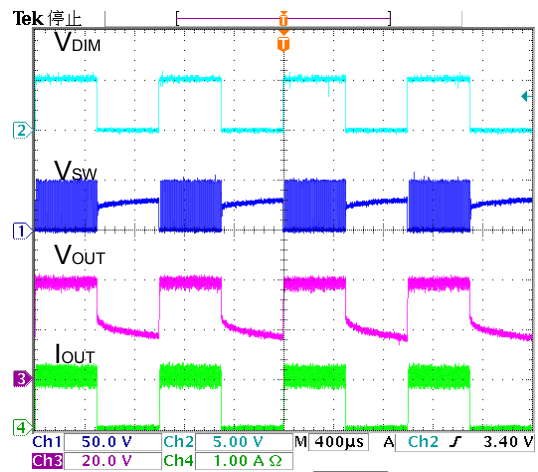

$V_{IN}=48V, R_{SEN}=0.1\Omega, D_{SW}=80\%$

Fig. 32

Switching Waveform

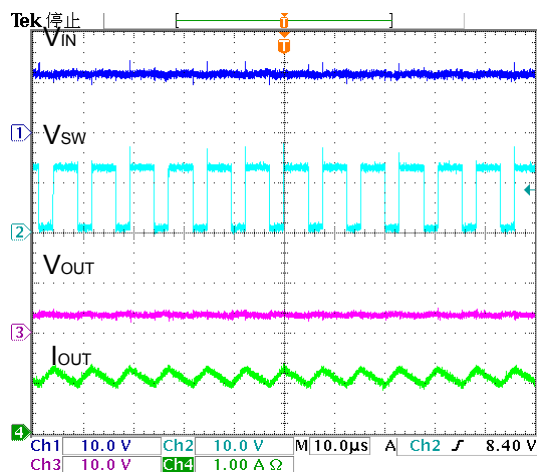

$V_{IN}=12V, R_{SEN}=0.28\Omega, 1\text{-LED}$

Fig. 33

MBI6661

60V, Step-Down, 1A LED Driver

Line Transient Response

Line Transient Response @ $V_{IN}=24V \leftrightarrow 36V$

$R_{SEN}=0.28\Omega$, 1-LED, $I_{OUT}=350mA$

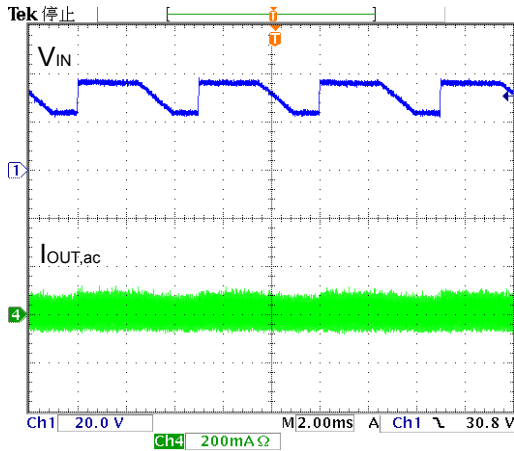

Fig. 34

$R_{SEN}=0.14\Omega$, 1-LED, $I_{OUT}=700mA$

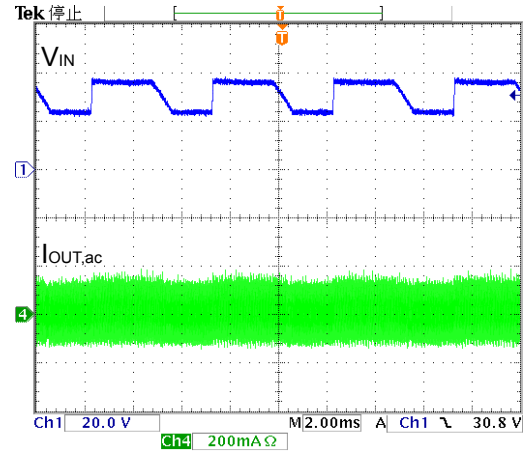

Fig. 35

$R_{SEN}=0.1\Omega$, 1-LED, $I_{OUT}=1000mA$

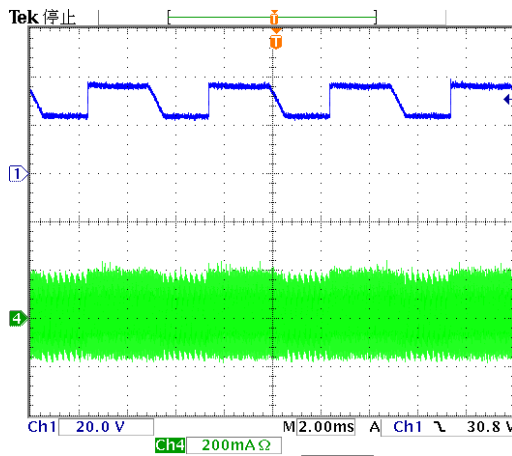
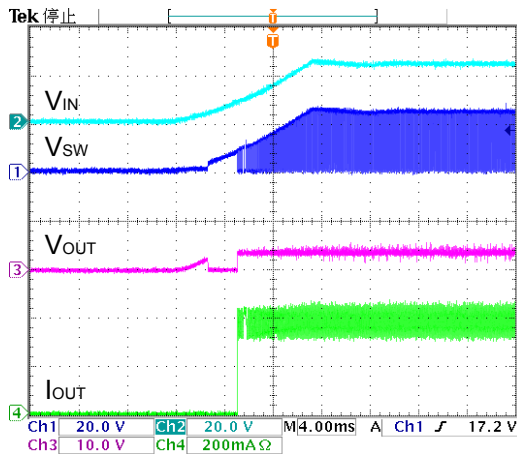

Fig. 36

Power ON/OFF Waveforms

Power On Waveform



$V_{IN}=24V$, $R_{SEN}=0.28\Omega$, 1-LED

Fig. 37

Power Off Waveform

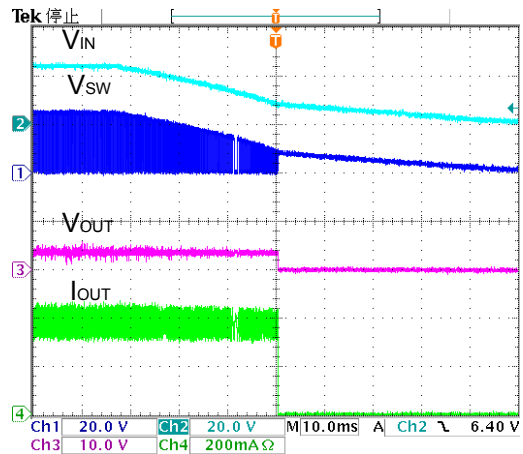

$V_{IN}=24V$, $R_{SEN}=0.28\Omega$, 1-LED

Fig. 38

MBI6661

60V, Step-Down, 1A LED Driver

Internal Propagation Delay Time

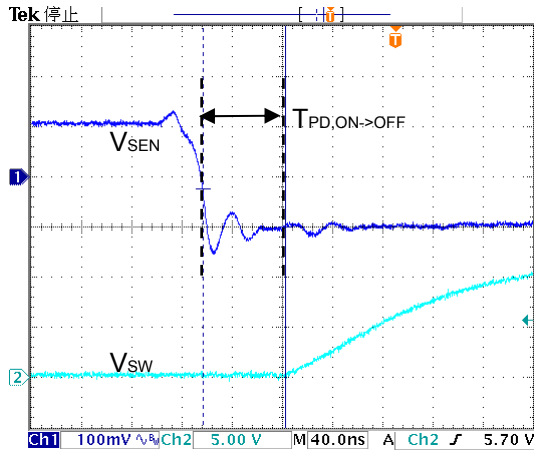

Fig. 39

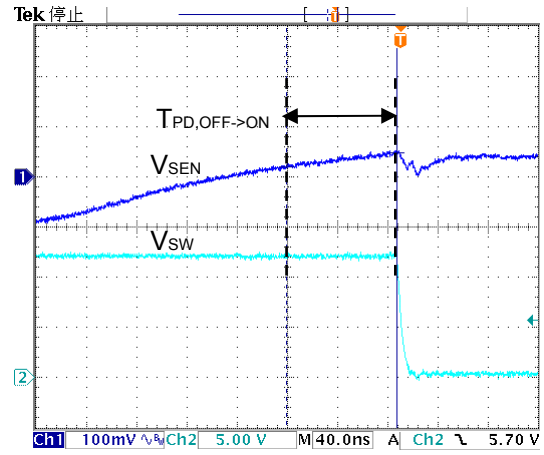

Fig. 40

MBI6661**60V, Step-Down, 1A LED Driver****Application Information**

MBI6661 is a simple and high efficient buck converter with the capability to drive up to 1A of loading. MBI6661 adopts hysteretic PFM control scheme to regulate loading and input voltage variations. The hysteretic PFM control requires no loop compensation bringing very fast load transient response and achieving excellent efficiency at light loading.

Setting Output Current

The output current (I_{OUT}) is set by an external resistor, R_{SEN} . The relationship between I_{OUT} and R_{SEN} is as below:

$$V_{SEN}=0.1V;$$

$$R_{SEN}=(V_{SEN}/I_{OUT})=(0.1V/I_{OUT});$$

$$I_{OUT}=(V_{SEN}/R_{SEN})=(0.1V/R_{SEN})$$

where R_{SEN} is the resistance of the external resistor connecting to SEN terminal and V_{SEN} is the voltage of the external resistor. The magnitude of current (as a function of R_{SEN}) is around 0.35A at 0.28Ω (R_{SEN}).

Minimum Input Voltage and Start-up Protection

The minimum input voltage is the sum of the voltage drops on R_{SEN} , R_S , DCR of L1, $R_{ds(on)}$ of internal MOSFET and the total forward voltage of LEDs. The dynamic resistance of LED, R_S , is the inverse of the slope in linear forward voltage model for LED. This electrical characteristic can be provided by LED manufacturers. The equivalent impedance of MBI6661 application circuit is shown in Fig. 41. As the input voltage is smaller than the minimum input voltage such as in the start-up condition, the output current will be larger than the preset output current. Thus, under this circumstance, the output current is limited to 1.15 times of the output current set by R_{SEN} .

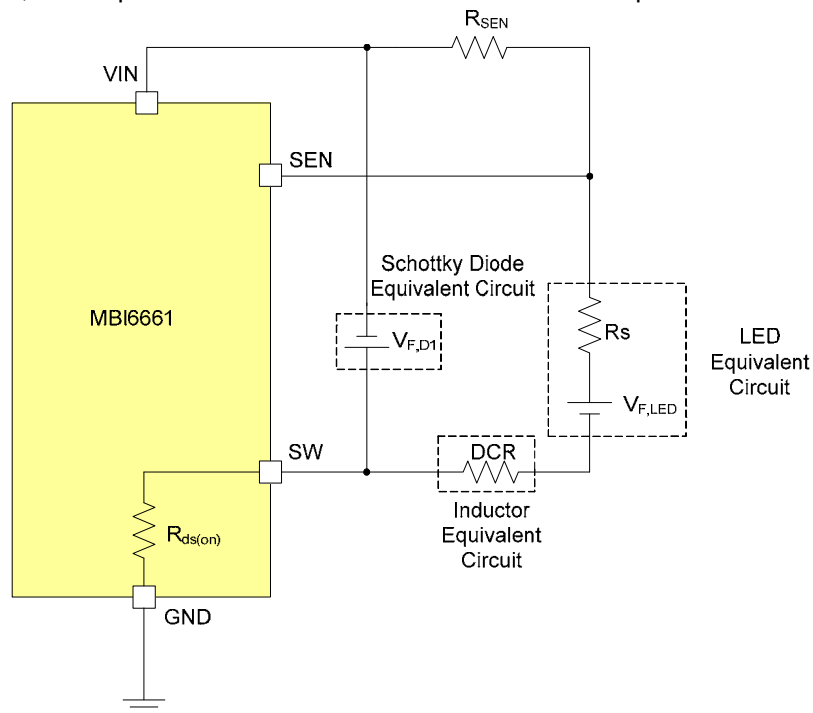

Fig. 41 The Equivalent Impedance of the MBI6661 Application Circuit

MBI6661

60V, Step-Down, 1A LED Driver

Under Voltage Lock Out Protection

When the voltage at VIN of MBI6661 is below 7.8V (typ.), the output current of MBI6661 will be turned off. When the VIN voltage of MBI6661 resumes to 8.0V (typ.), the output current of MBI6661 will be turned on again. Please refer to the power off waveform in Fig. 38.

Dimming

The dimming of LEDs can be performed by applying PWM signals to DIM pin. A logic low (below 0.8V) at DIM will disable the internal MOSFET and shut off the current flow to the LED array. An internal pull-up circuit ensures that MBI6661 is ON when DIM pin is unconnected. Therefore, the need for an external pull-up resistor will be eliminated. The following Fig. 42 and 43 show good linearity in dimming application of MBI6661.

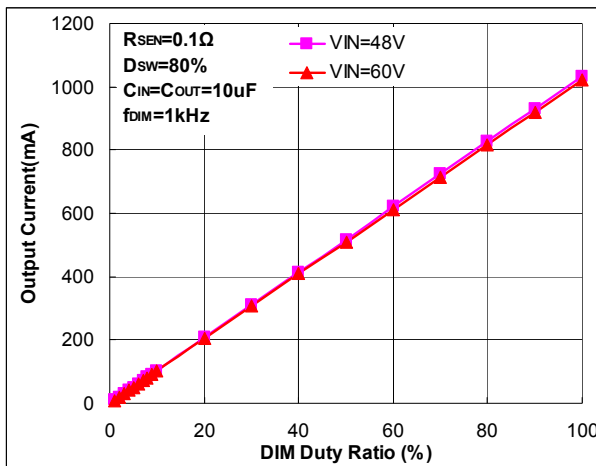

Fig. 42 DIM Duty Cycle: 1% ~ 100%

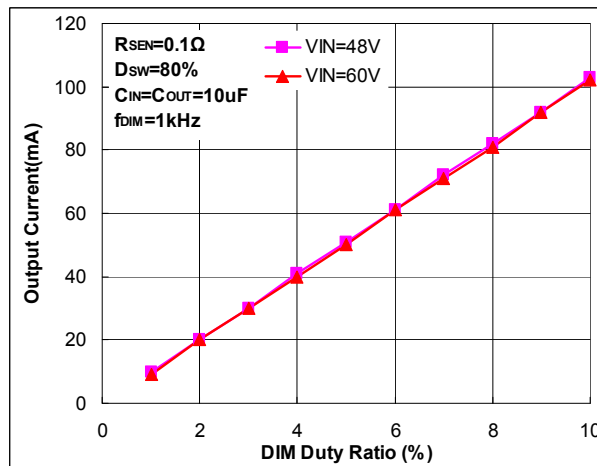

Fig. 43 DIM Duty Cycle: 1% ~ 10%

MBI6661**60V, Step-Down, 1A LED Driver****LED Open-Circuit Protection**

When any LED connected to MBI6661 is open-circuited, the output current of MBI6661 will be turned off. The waveform is shown in Fig. 44.

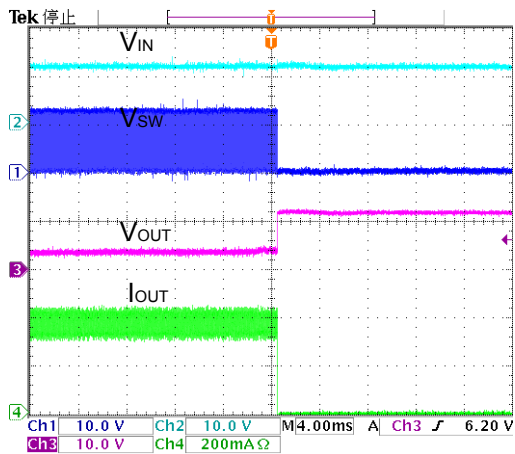

Fig. 44 LED Open-Circuit Protection

LED Short-Circuit Protection

When any LED connected to the MBI6661 is short-circuited, the output current of MBI6661 will be limited to its preset value as shown in Fig. 45.

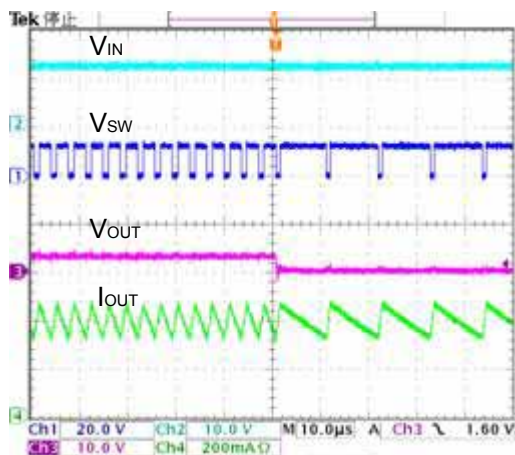

Fig. 45 LED Short-Circuit Protection

MBI6661

60V, Step-Down, 1A LED Driver

Over Current Protection

MBI6661 offers over current protection to against destructive damage which results from abnormal excessive current flow through. The function is activated when the LED current reaches the threshold which is approximately 1.8A as shown I_{SW} in Fig. 46. Then, the integrated power switch of MBI6661 will be turned off. When the function is activated, it will not be removed until power reset is taken.

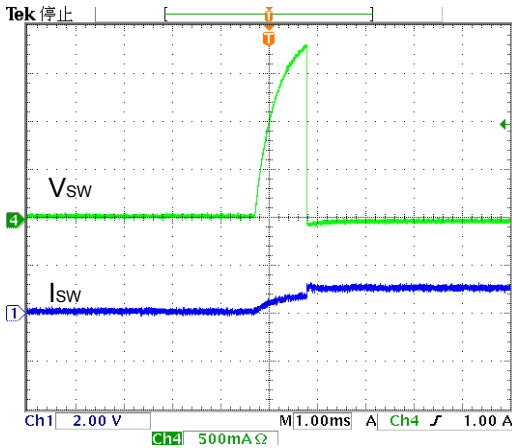

Fig 46 Over Current Protection

TP Function (Thermal Protection)

When the junction temperature, T_j , exceeds the threshold 155°C, TP function turns off the output current by disabling the internal switch. The waveform can refer to Fig. 47. The SW stops switching results in output current decreasing. Thus, the junction temperature starts to decrease. As soon as the temperature is below 125°C, the internal switch turns on again and offers regulated output current. The switching of on-state and off-state are at a high frequency; thus, the blinking is imperceptible. The average output current is limited, and therefore, the IC is protected from being overheated.

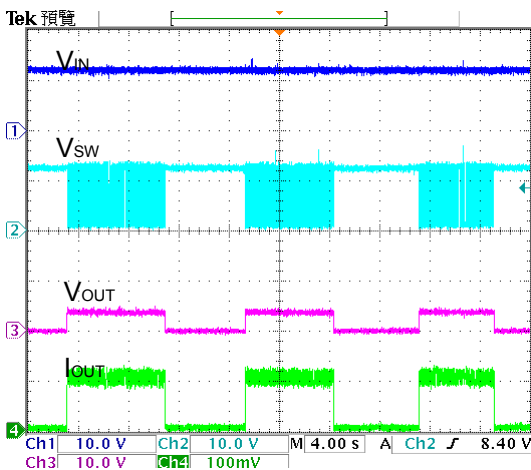

Fig. 47 Thermal Protection

MBI6661

60V, Step-Down, 1A LED Driver

Design Consideration

Switching Frequency

To achieve better output current accuracy, the switching frequency should be determined by minimum on/off time of SW waveform. For example, if the duty cycle of MBI6661 is larger than 0.5, then the switching frequency should be determined by the minimum off time, and vice versa. Thus, the switching frequency of MBI6661 is:

$$f_{SW} = \frac{1}{T_S} = \frac{1}{\frac{T_{OFF,min}}{(1-D)}}, \text{ when the duty cycle is larger than 0.5} \quad (1)$$

$$\text{or } f_{SW} = \frac{1}{T_S} = \frac{1}{\frac{T_{ON,min}}{D}}, \text{ when the duty cycle is smaller than 0.5.} \quad (2)$$

The switching frequency is related to efficiency (better at low frequency), the size/cost of components (smaller/cheaper at high frequency), and the amplitude of output ripple voltage and current (smaller at high frequency). The slower switching frequency comes from the large inductance. In many applications, the sensitivity of EMI limits the switching frequency of MBI6661. To avoid audible noise, it is recommended to range the switching frequency from 40KHz to 1.0MHz.

LED Ripple Current

An LED constant current driver, such as MBI6661, is designed to control the current through the cascaded LEDs, instead of the voltage across them. Higher LED ripple current allows the use of smaller inductance, smaller output capacitance and even without an output capacitor. The advantages of higher LED ripple current include PCB size minimization and cost reduction since no output capacitor is required. Lower LED ripple current requires larger inductance, and output capacitor. The advantages of lower LED ripple current include LED life time extension and heat reduction on LEDs. The recommended ripple current is from 5% to 20% of normal LED current.

Component Selection

Inductor Selection

The inductance is determined by two factors: the switching frequency and the inductor ripple current. The calculation of the inductance, L1, can be described as

$$L1 > (V_{IN} - V_{OUT} - V_{SEN} - (R_{ds(on)} \times I_{OUT})) \times \frac{D}{f_{SW} \times \Delta I_L}$$

where

$R_{ds(on)}$ is the on-resistance of internal MOSFET of MBI6661. The typical value is 0.35Ω.

D is the duty cycle of MBI6661, $D = V_{OUT}/V_{IN}$.

f_{SW} is the switching frequency of MBI6661.

I_L is the ripple current of inductor, $I_L = (1.15 \times I_{OUT}) - (0.85 \times I_{OUT}) = 0.3 \times I_{OUT}$.

For inductor selection, not only the inductance but also the saturation current should be considered as the factors to affect the performance of the module. In general, it is recommended to choose an inductor with 1.5 times of LED current as the saturation current. Also, the larger inductance gains the better line/load regulation. However, the inductance and saturation current become a trade-off at the same inductor size. An inductor with shield is recommended to reduce the EMI interference; however, this is another trade-off with heat dissipation.

MBI6661

60V, Step-Down, 1A LED Driver

Schottky Diode Selection

MBI6661 needs a flywheel diode, D1, to carry the inductor current when the MOSFET is off. The recommended flywheel diode is schottky diode with low forward voltage for better efficiency. Two factors determine the selection of schottky diode. One is the maximum reverse voltage. The recommended rated voltage of the reverse voltage is at least 1.5 times of input voltage. The other is the maximum forward current, which works when the MOSFET is off. And the recommended forward current is 1.5 times of output current. Users should carefully choose an appropriate schottky diode to perform low leakage current at high temperature.

Input Capacitor Selection

The input capacitor, C_{IN} , can supply pulses of current for MBI6661 when the MOSFET is on. And C_{IN} is charged by the input voltage when the MOSFET is off. As the input voltage is lower than the tolerable input voltage, the internal MOSFET of MBI6661 remains constantly on, and the LED current is limited to 1.15 times of normal current. Under the circumstance, the selection of the capacitor is more important since higher current has to be handled. The recommended value of input capacitor is 10 μ F to stabilize the lighting system.

The rated voltage of input capacitor should be at least 1.5 times of input voltage. A tantalum or ceramic capacitor is recommended to be input capacitor. The advantages of tantalum capacitor are high capacitance and low ESR. The advantages of ceramic capacitor are high frequency characteristic, small size and low cost. For higher rating and capacitance concern, an electrolytic capacitor can also be used as input capacitor.

For better power integrity, it is suggest that to place a 0.1-1 μ F ceramic capacitor parallel input capacitor and position as close to VIN pin as possible.

Output Capacitor Selection (Optional)

A capacitor paralleled with cascaded LEDs can reduce the LED ripple current and allow smaller inductance.

MBI6661

60V, Step-Down, 1A LED Driver

PCB Layout Consideration

To enhance the efficiency and stabilize the system, careful considerations of PCB layout is important. Several factors should be considered as below:

1. A complete ground area is helpful to eliminate the switching noise.
2. Keep the IC's GND pin and the ground leads of input and output filter capacitors less than 5mm.
3. To maximize output power efficiency and minimize output ripple voltage, use a ground plane and solder the IC's GND pin directly to the ground plane.
4. To stabilize the system, the heat sink of MBI6661 is recommended to connect to ground plane directly.
5. Enhance the heat dissipation, the area of ground plane, which IC's heat sink is soldered on, should be as large as possible.
6. The input capacitor should be placed to IC's VIN pin as close as possible.
7. To avoid the parasitic effect of trace, the R_{SEN} should be placed to IC's VIN and SEN pins as close as possible.
8. The area, which is composed of IC's SW pin, schottky diode and inductor, should be wide and short.
9. The path, which flows large current, should be wide and short to eliminate the parasite element.
10. When SW is ON/OFF, the direction of power loop should keep the same way to enhance the efficiency. The sketch is shown as Fig. 48.
11. To avoid unexpected damage or malfunction to the driver board, users should pay attention to the quality of soldering in the PCB by checking if cold welding or cold joint happens between the pins of IC and PCB.

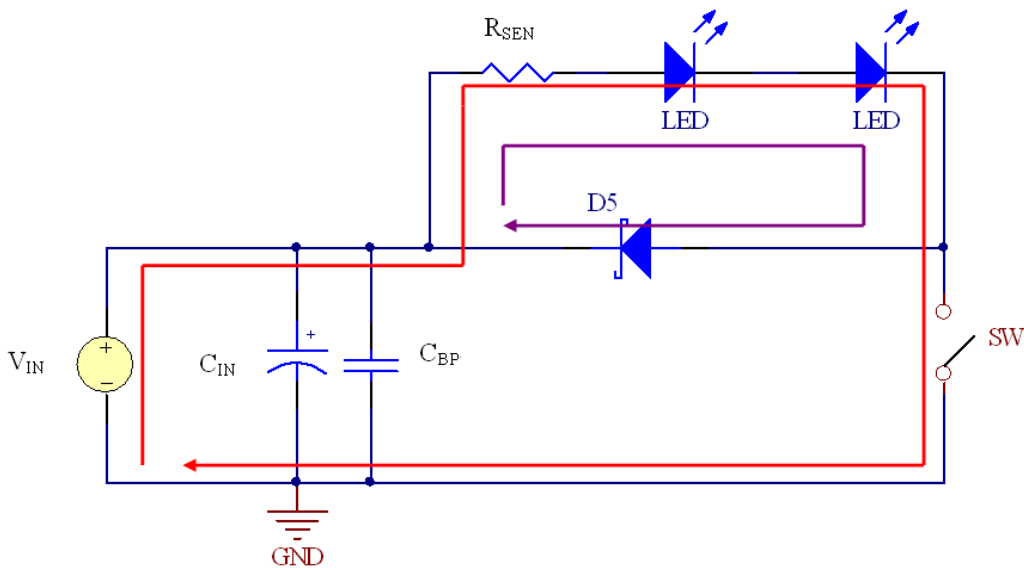
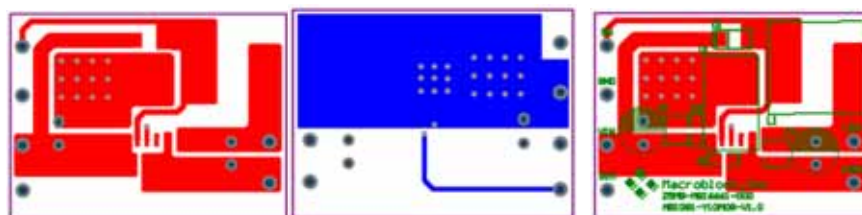

Fig. 48 Power Loop of MBI6661

PCB Layout

Fig. 49 is the recommended layout diagram of the MBI6661GSD package.



Top layer Bottom layer Top-Over layer
Fig. 49 The Layout Diagram of the MBI6661GSD

MBI6661

60V, Step-Down, 1A LED Driver

Soldering Process of "Pb-free" Package Plating*

Macroblock has defined "Pb-Free & Green" to mean semiconductor products that are compatible with the current RoHS requirements and selected 100% pure tin (Sn) to provide forward and backward compatibility with both the current industry-standard SnPb-based soldering processes and higher-temperature Pb-free processes. Pure tin is widely accepted by customers and suppliers of electronic devices in Europe, Asia and the US as the lead-free surface finish of choice to replace tin-lead. Also, it adopts tin/lead (SnPb) solder paste, and please refer to the JEDEC J-STD-020C for the temperature of solder bath. However, in the whole Pbfree soldering processes and materials, 100% pure tin (Sn) will all require from 245°C to 260°C for proper soldering on boards, referring to JEDEC J-STD-020C as shown below.

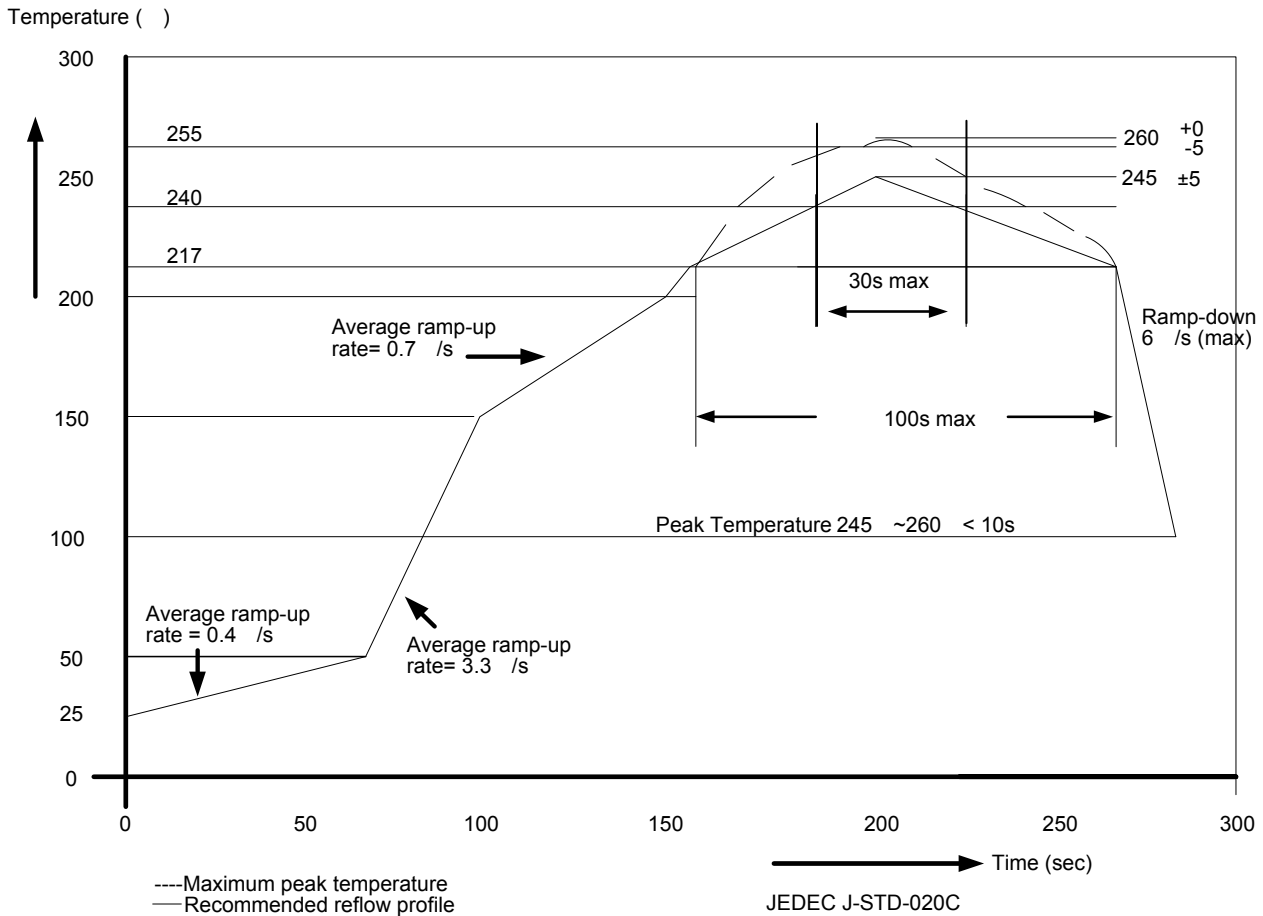

Package Thickness	Volume mm ³ <350	Volume mm ³ 350-2000	Volume mm ³ 2000
<1.6mm	260 +0 °C	260 +0 °C	260 +0 °C
1.6mm – 2.5mm	260 +0 °C	250 +0 °C	245 +0 °C
2.5mm	250 +0 °C	245 +0 °C	245 +0 °C

* For details, please refer to Macroblock's "Policy on Pb-free & Green Package".

MBI6661**60V, Step-Down, 1A LED Driver**

Package Power Dissipation (PD)

The maximum power dissipation, $P_D(\max) = (T_j - T_a) / R_{th(j-a)}$, decreases as the ambient temperature increases.

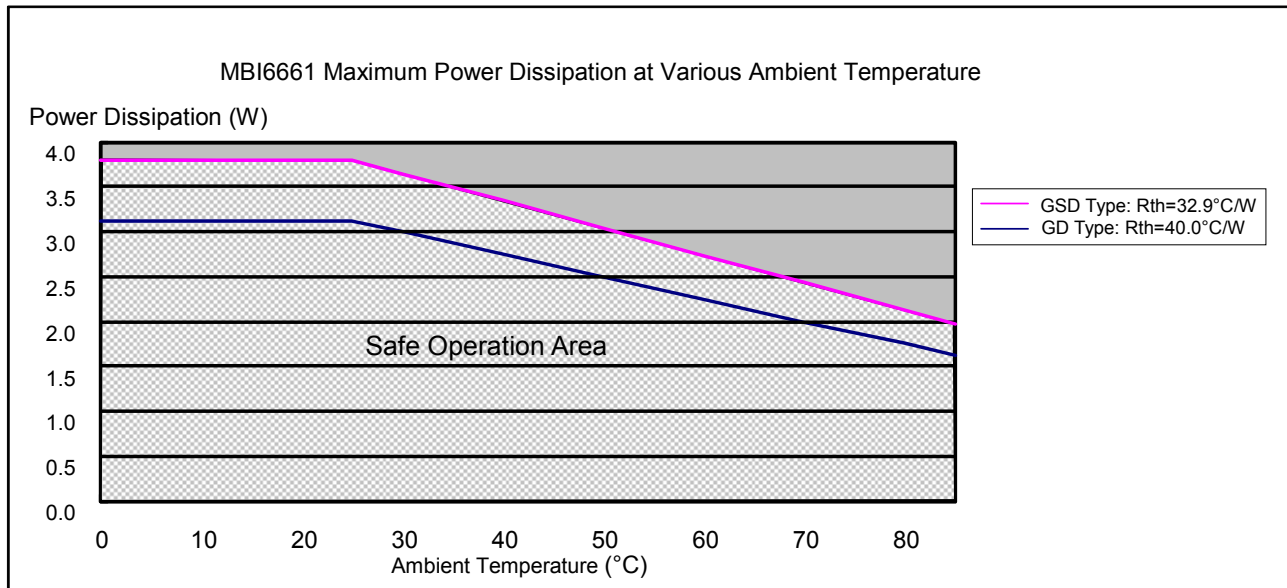

MBI6661

60V, Step-Down, 1A LED Driver

Outline Drawing

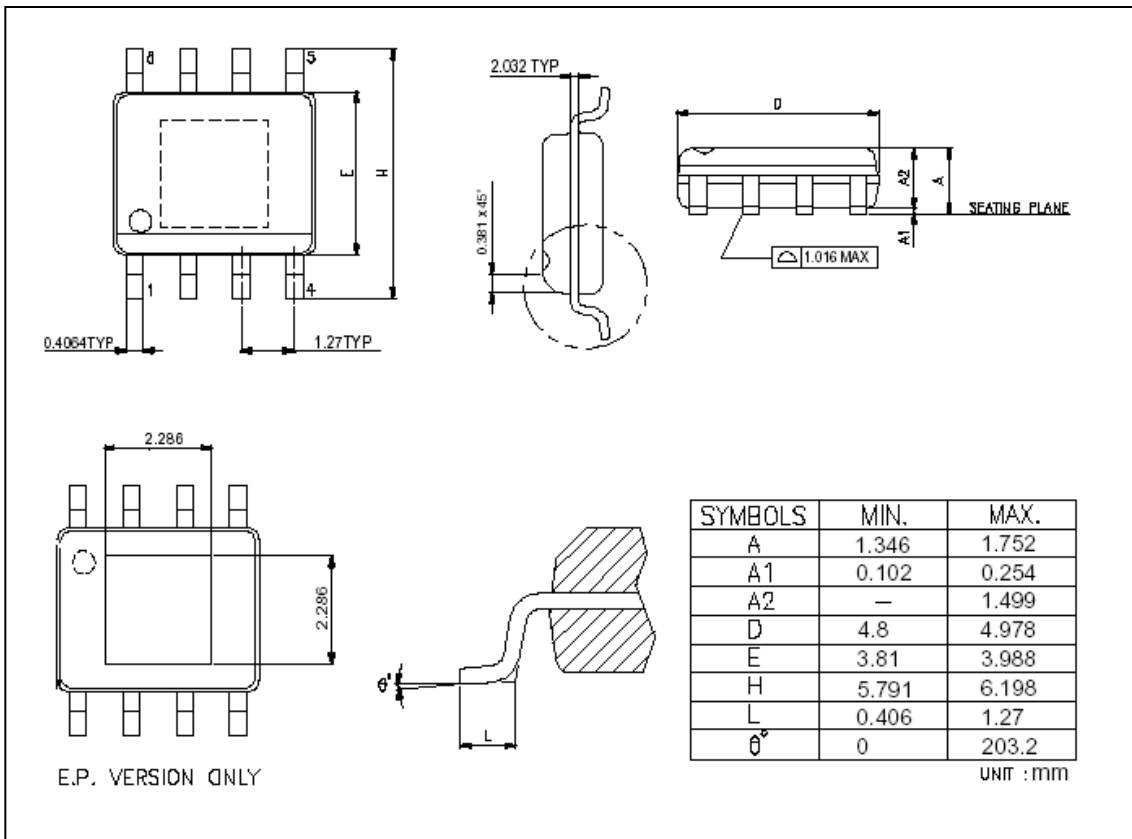

MBI6661GD Outline Drawing

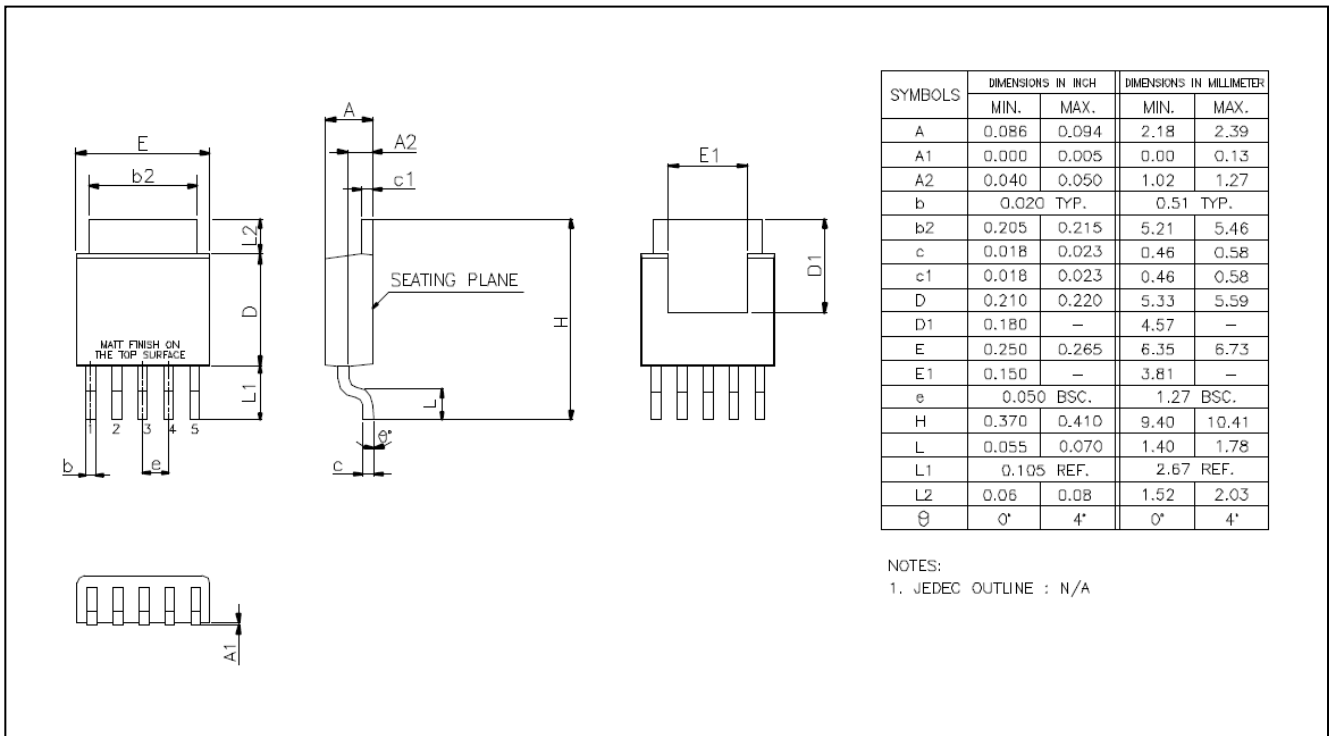

MBI6661GSD Outline Drawing

Note1: The unit for the outline drawing is mm.

Note2: Please use the maximum dimensions for the thermal pad layout. To avoid the short circuit risk, the vias or circuit traces shall not pass through the maximum area of thermal pad.

MBI6661**60V, Step-Down, 1A LED Driver**

Product Top Mark Information

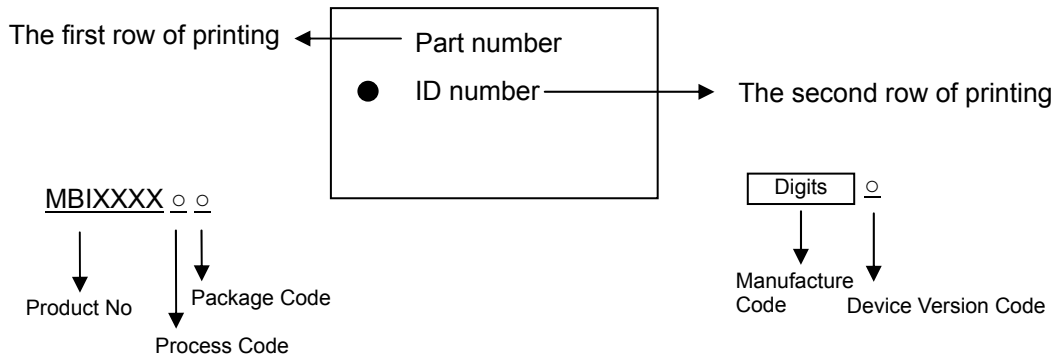
GSD(TO-252)/GD(SOP-8)

Product Revision History

Datasheet version	Device Version Code
V1.00	A
V1.01	A
V2.00	B

Product Ordering Information

Product Ordering Number*	RoHS Compliant Package Type	Weight (g)
MBI6661GD-B	SOP8L-150-1.27	0.079g
MBI6661GSD-B	TO-252-5L	0.282g

*Please place your order with the "product ordering number" information on your purchase order (PO).

Disclaimer

Macroblock reserves the right to make changes, corrections, modifications, and improvements to their products and documents or discontinue any product or service. Customers are advised to consult their sales representative for the latest product information before ordering. All products are sold subject to the terms and conditions supplied at the time of order acknowledgement, including those pertaining to warranty, patent infringement, and limitation of liability.

Macroblock's products are not designed to be used as components in device intended to support or sustain life or in military applications. Use of Macroblock's products in components intended for surgical implant into the body, or other applications in which failure of Macroblock's products could create a situation where personal death or injury may occur, is not authorized without the express written approval of the Managing Director of Macroblock.

Macroblock will not be held liable for any damages or claims resulting from the use of its products in medical and military applications.

All text, images, logos and information contained on this document is the intellectual property of Macroblock.

Unauthorized reproduction, duplication, extraction, use or disclosure of the above mentioned intellectual property will be deemed as infringement.